



Dornier Delta III

DORNIER DELTA® III

THE MOBILE
ESWL® WORKSTATION

A GLOBAL LEADER

Dornier MedTech® is a global medical device company known for its pioneering technologies in lithotripsy and revolutionary therapies in urology. Dornier works closely with physicians, healthcare providers and research groups to ensure their Advanced Imaging Urology Tables, ESWL® Systems, and Surgical Lasers lead technology and improve life across the globe.

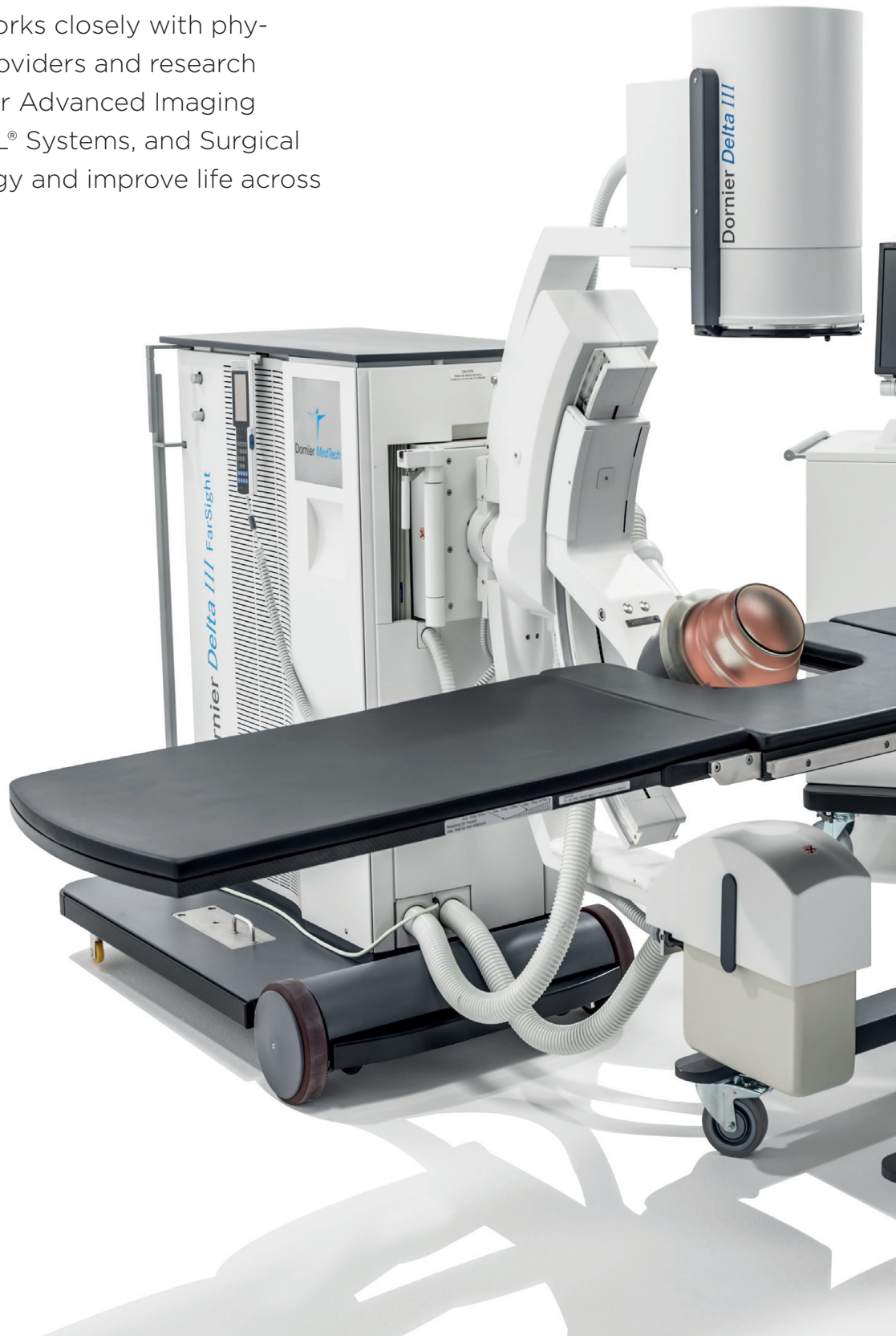

DORNIER DELTA® III

CUTTING-EDGE AND FLEXIBEL

The compact and easy-to-transport Dornier Delta® III combines Dornier's proven extracorporeal shockwave system with state-of-the-art imaging technology, a multifunctional table and a central control system.



The therapy head has a wide range of movement, allowing the patient to lie comfortably on their back at all times

Optical coupling control OptiCouple® for reducing the number and power of shockwaves

EMSE with a penetration depth of up to 170 mm also allows obese patients to be treated

Three imaging modes (isocentric outline ultrasound, inline ultrasound and x-ray) can be used in any combination

Gentle treatment thanks to the therapy head's spacious coupling area

The motorised, multifunctional patient table is low for easy access

BEST RESULTS

94.5 % STONE FREE RATE*

Highest stone free rate is achieved by

- the new therapy head/EMSE with a focal depth of 170 mm for a broader spectrum of patients
- the unique optical coupling control Dornier OptiCouple® for higher efficiency
- the powerful X-ray generator for excellent image quality

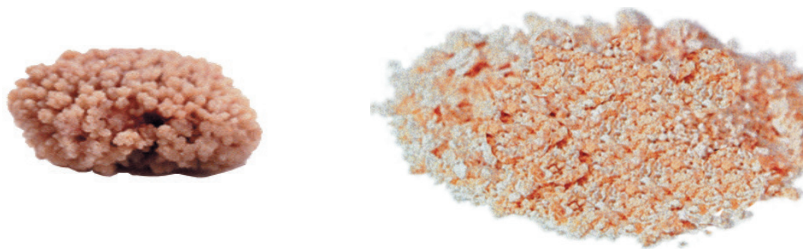

“Working with the EMSE 180 and OptiCouple®, we were able to optimize treatment success at our institution. The combination of larger EMSE diameter and shockwave penetration helped us treat more patients; in addition, video surveillance of the coupling with OptiCouple® has improved the effectiveness of our treatment substantially.”

– Prof. Gerd Lümmer, Troisdorf, Germany

* Study: M. Mohammadi, T. Au, N. Milz, S. Osswald, A. Zintl, H. P. Bastian, G. Lümmer, St. Josef-Hospital Troisdorf Study Hospital: “The Clinical Experience with the New Dornier Shock Wave Source EMSE 180 for ESWL”, Düsseldorf, 60 Congress of the North Rhine-Westphalian Society of Urology, (April 3 – 4, 2014).



EXCELLENT IMAGING

3 IMAGING MODES

Stone localization can be accomplished using any one of the three imaging modes offered on Dornier Delta® III - inline or outline ultrasound or X-ray. Either ultrasound imaging system can be applied with fluoroscopy for real time dual imaging.

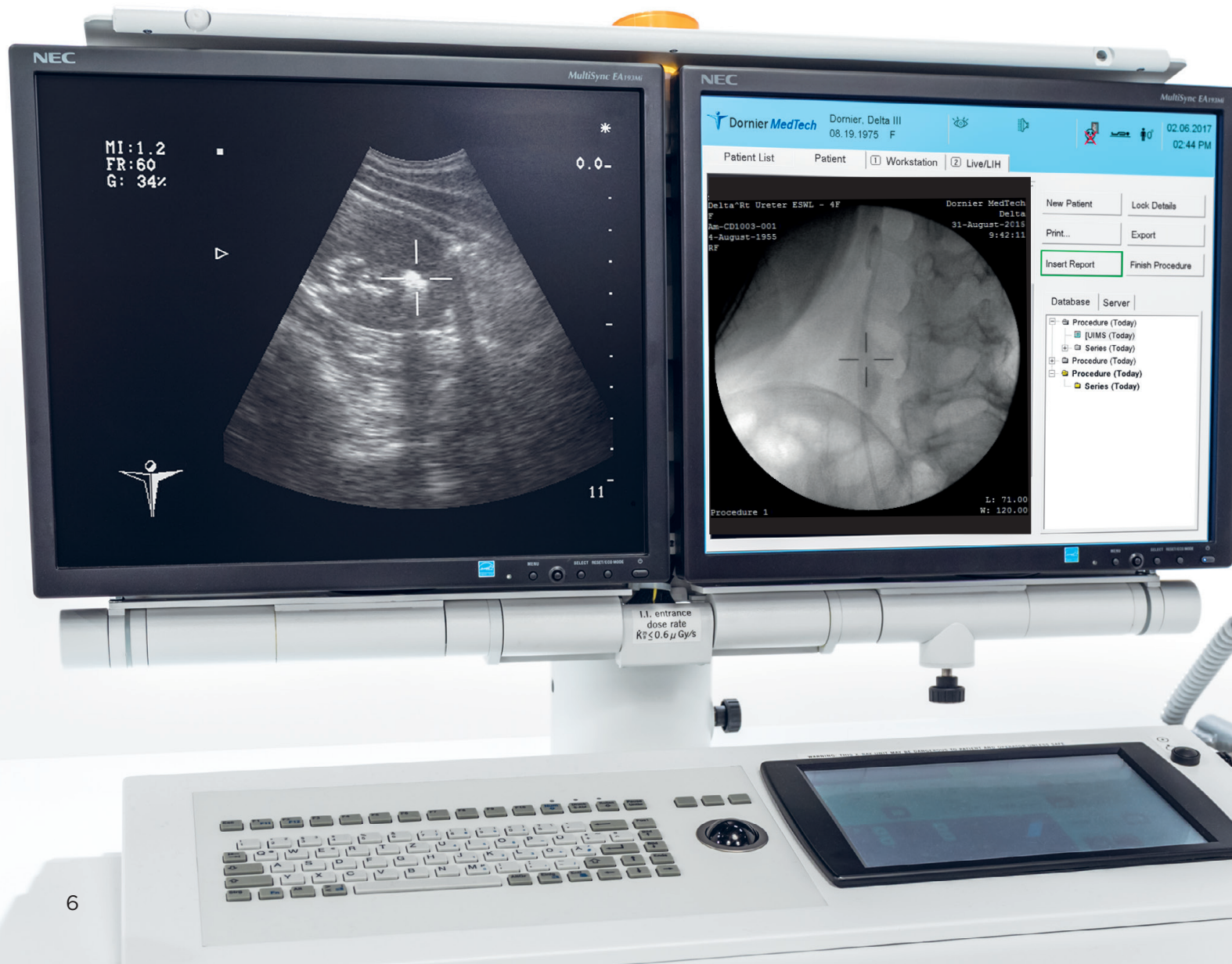

NEW X-RAY SYSTEM

Thanks to the new powerful X-ray generators with 7.5 or 15 kw, the new X-ray system offers high image quality, even in obese patients.

Additional advantages:

- Touch screen interface
- Iris and zoom preview
- Actively cooled X-ray tube with water circuit

OBLIQUE C-ARM MOVEMENT

In addition to the vertical projection, two X-ray oblique (CC) projections are available to ensure excellent stone localization even if ribs or intestinal gas overlay the stone.

The excellent X-ray imaging is also supported by the radiolucent carbon fiber mid-section of the Relax+-table.

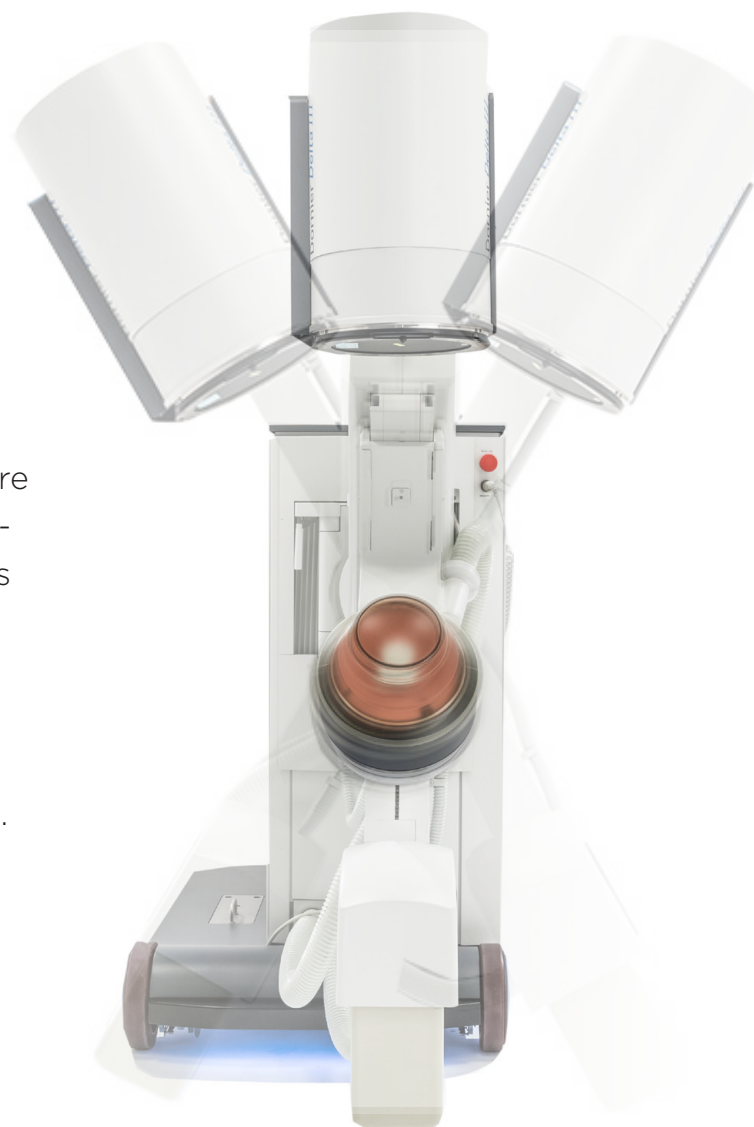



OPTIMIZED ULTRASOUND

ISOCENTRIC

The detachable isocentric localization arm offers optimized movement ranges and ergonomics. Isocentric ultrasound provides excellent image quality and imaging flexibility. Moreover it allows real-time monitoring of the disintegration process.

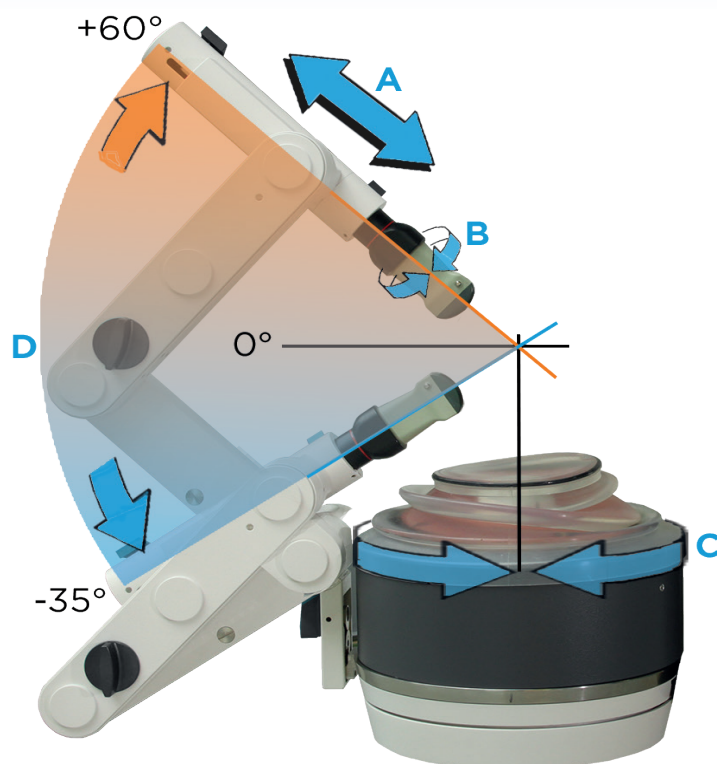

INLINE ULTRASOUND FARSIGHT®

FarSight® with an integrated new 3 or 4 MHz inline transducer provides best imaging access to distal ureteric stones and stones in the biliary system. There is no disruption of shock wave energy by transducer movement along the shock wave axis.



HIGHER EFFICIENCY

OPTICAL COUPLING CONTROL

For maximum ESWL® treatment quality, the coupling of the shockwave source to the patient is one of the most important factors in energy transfer and hence in the quality of the stone fragmentation. Air bubbles, cushion folds and incomplete coupling have an adverse effect on the propagation of the shockwaves and decrease the fragmentation efficiency.

With OptiCouple®, the quality of the coupling can be easily monitored by the user at any time of the procedure. If needed, the user intervenes and improves the coupling within seconds and continuously ensures the best coupling quality throughout the treatment.

Removal of visualized air bubbles by the user



Before, during and after wiping



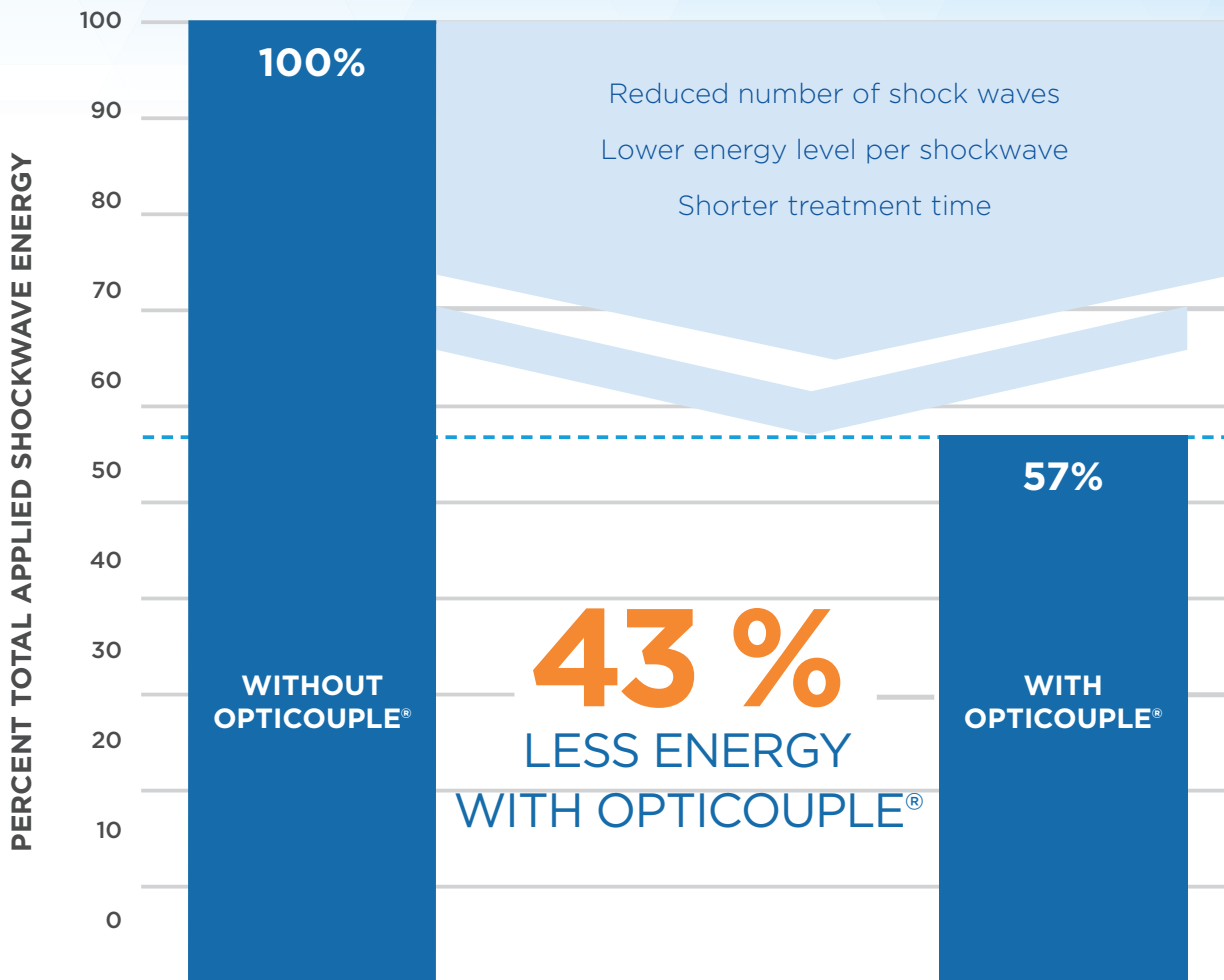

Taïlly GG, Taïlly-Cusse MM: "Optical Coupling Control: An Important Step Toward Better Lithotripsy", J Endourol (2014) 28(11):1368-73.

BENEFITS

REDUCED NUMBER OF SHOCK WAVES

- Increases the life of the shock wave source

LOWER ENERGY LEVEL PER SHOCKWAVE

- Minimizes side effects / painless treatment

SHORTER TREATMENT TIME --> MORE TREATMENTS PER DAY

- Allows better time management and more treatments per day

NEW THERAPY HEAD



NEW SHOCK WAVE SOURCE EMSE 180

- Penetration depth of 170 mm - well suited also for obese patients.
- Large coupling area of the therapy head for gentle treatment.

NEW THERAPY HEAD

The new Delta III therapy head features best in class movement and access.

- +63° / -63° degrees of therapy treatment positions through motorized orbital movement
- Continuous overtable and undertable therapy head positioning offers unparalleled flexibility in adapting the ESWL® approach to stone location. The patients can always remain comfortably in supine position.
- Motorized axial rotation of the therapy c-arm by 220° for optimized coupling to the patient.

*220° axial rotation of the
therapy head*

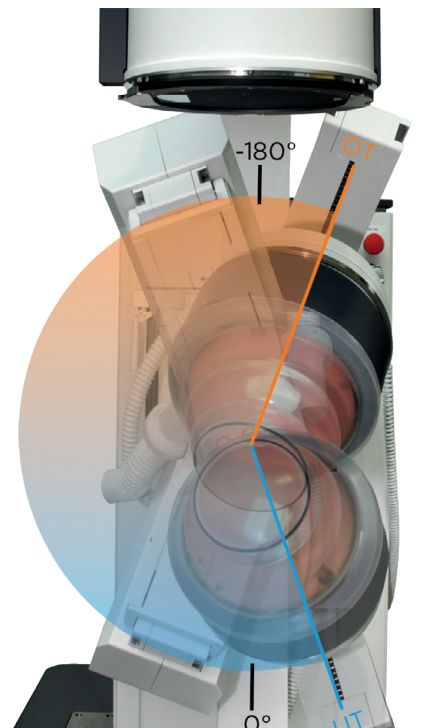

Dorn

DEGREES OF ACCESS

+ 63°

- 63°

ENHANCED ERGONOMICS

UNIFIED HAND CONTROL

One single hand control to operate the lithotripter, table and X-ray C arm movements with graphical user interface.

- Therapy head in over and under table position and all other movements
- Patient table x, y, z axis / Table tilt +/- 15 degree
- X-Ray C-arm CC- / PA / CC+



▲ Unified Hand Control

REMOTE CONTROL VERSION

Mandatory when a separate X-ray control room is required

- Remote controlled Urology Information Management System (UIMS®)
- Remote controlled Dornier Delta® III
- Remote controlled X-ray system
- Remote controlled Dornier Relax+



PATIENT TABLE

The Dornier Relax+ is a transportable, motorized multifunctional table for extracorporeal shock wave lithotripsy (ESWL®). The modular design and the comprehensive range of available accessories allows the table to be configured individually. The minimum table height position of 78 mm allows ambulatory patients to easily access and sit on the table.



↑
MINIMUM TABLE HEIGHT
POSITION OF 78 CM
FOR EASY ACCESS
↓

DORNIER DELTA® III WAS DEVELOPED AND MANUFACTURED BY DORNIER MEDTECH

KNOWN FOR ITS PIONEERING TECHNOLOGIES AND
REVOLUTIONARY THERAPIES IN UROLOGY, DORNIER
IS LEADING TECHNOLOGY AND IMPROVING LIFE ALL
ACROSS THE GLOBE.

Headquarters

Dornier MedTech GmbH
Argelsrieder Feld 7
82234 Wessling
Deutschland

America

Dornier MedTech America, Inc.
1155 Roberts Boulevard N.W.
Kennesaw, Georgia 30144
Tel.: +1 770 426-1315
Fax: +1 770 514-6291
E-Mail: info@dornier.com

Asia/Pacific

Dornier MedTech Asia Pte Ltd
2 Venture Drive
#23-18 Vision Exchange
Singapur 608526
Tel.: +65 6572 6068
Fax: +65 6572 6093
E-Mail: infoasia@dornier.com

Japan

Dornier MedTech Japan
Meguro Estate Building
3-8-5 Kami-Ohsaki
Shinagawa-ku, Tokio 141-0021
Japan
Tel.: +81 3 3280-3550
Fax: +81 3 3280-3555
E-Mail: info.japan@domedtech.co.jp

Europe

Dornier MedTech Europe GmbH
Argelsrieder Feld 7
82234 Wessling
Germany
Phone: +49 8153 888-625
Fax: +49 8153 888-444
Email: infoeurope@dornier.com

Dornier MedTech Italia s.r.l.
Via Arrigo Cavaglieri N. 26
00173 Rome
Italy
Phone: +39 06 7235-289
Fax: +39 06 7235-302

Dornier MedTech España, S.L.
Av. Alcalde Barnils, 64-68 -
Módulo A - 1ª 3ª
08174 Sant Cugat del Vallés
(Barcelona)
Spain
Phone: +34 93 2039316
Fax: +34 93 2053814

Dornier MedTech France SARL
Ferme de St Paul
1545 route d'Epagny
74330 Sillingy
France
Phone: +33 450 221894
Fax: +33 450 242463

Dornier MedTech Europe GmbH
Moscow Representative Office
Uliza Mytnaya 3
Office 21
119049 Moscow
Russia
Phone: +7 495 73951-32
Fax: +7 495 73951-33

www.dornier.com

LEADING TECHNOLOGY. IMPROVING LIFE.

